

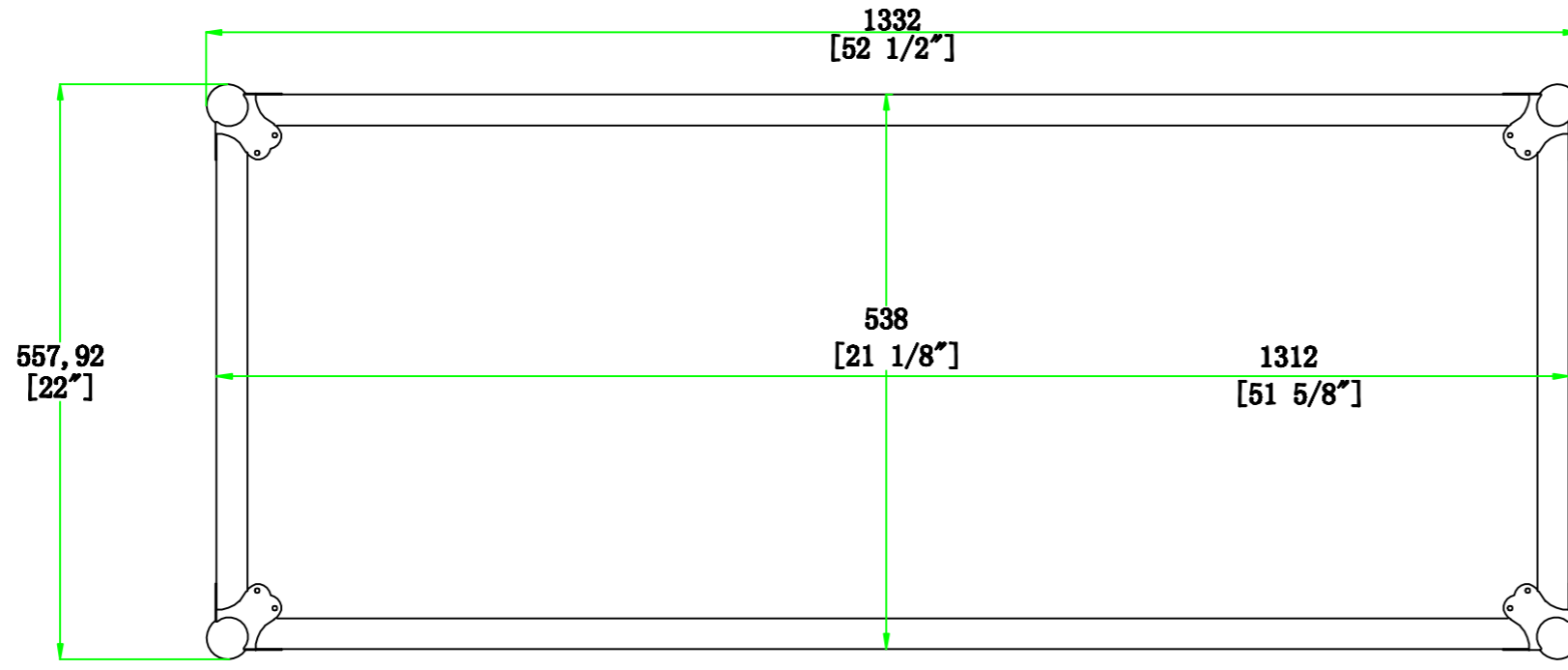

AC-2PLASMA42W

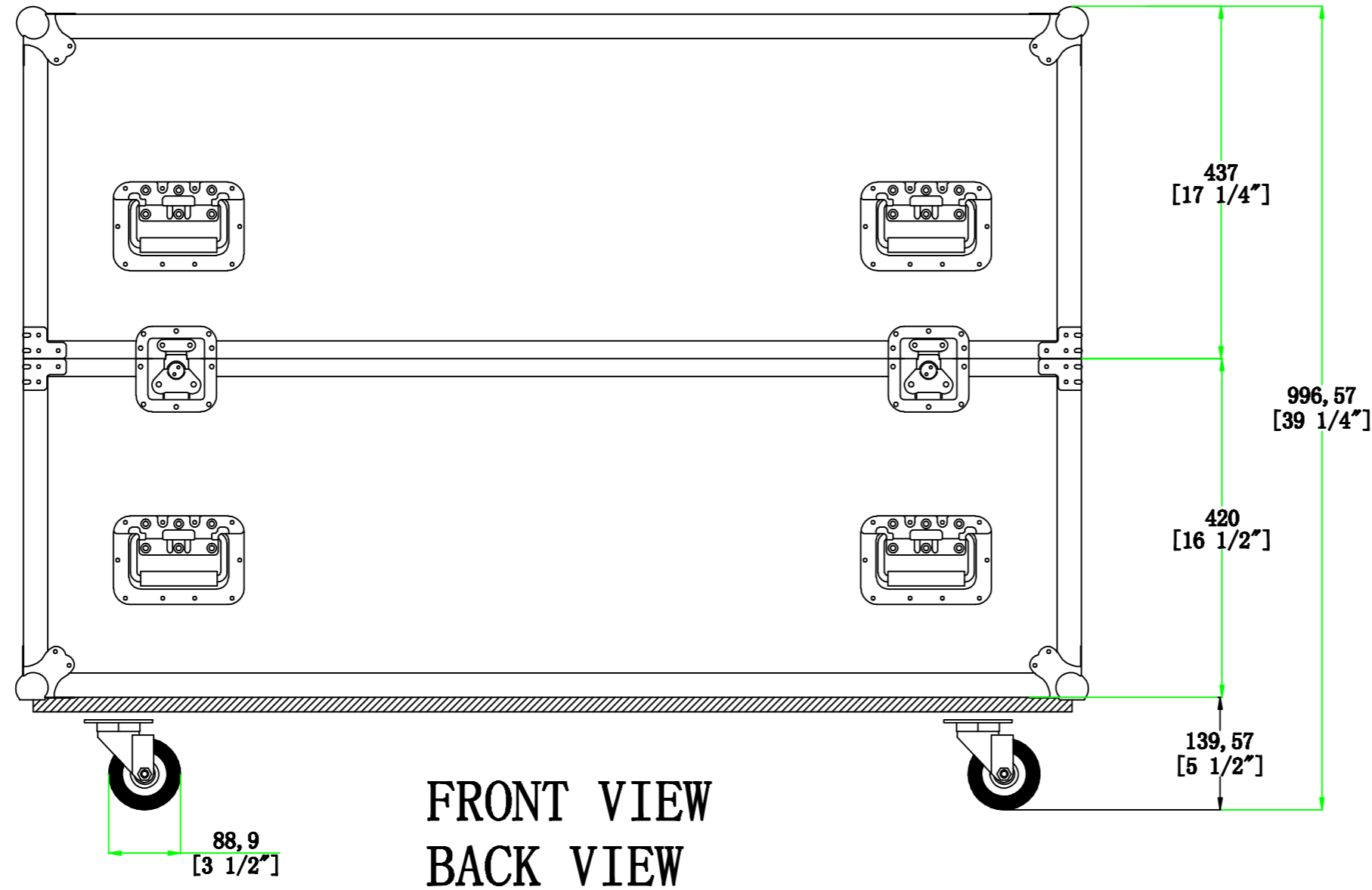

TOP VIEW



FRONT VIEW
BACK VIEW

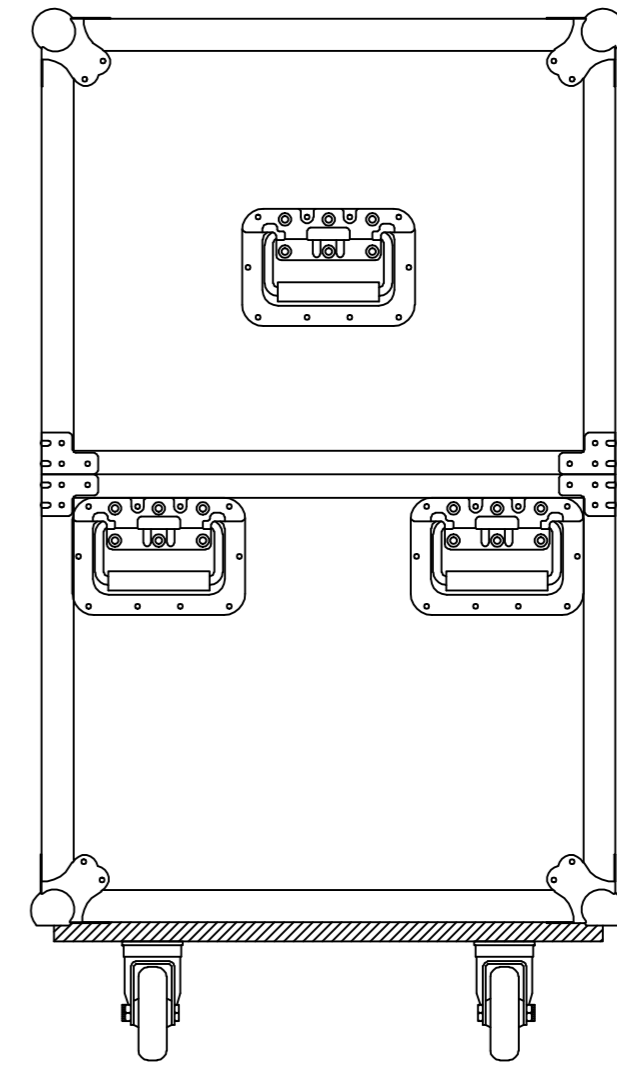

LEFT VIEW
RIGHT VIEW

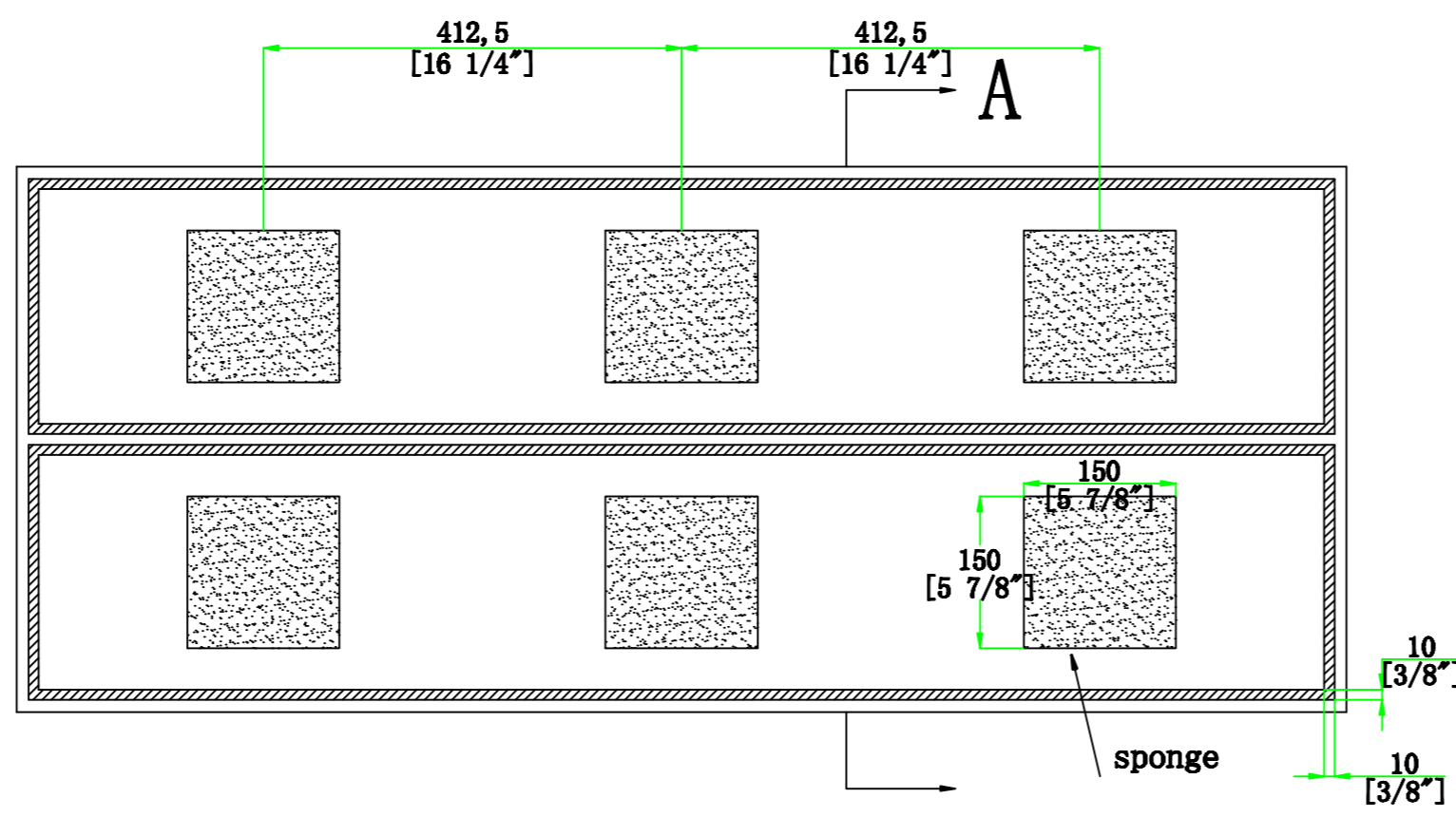

BOTTOM VIEW OF COVER

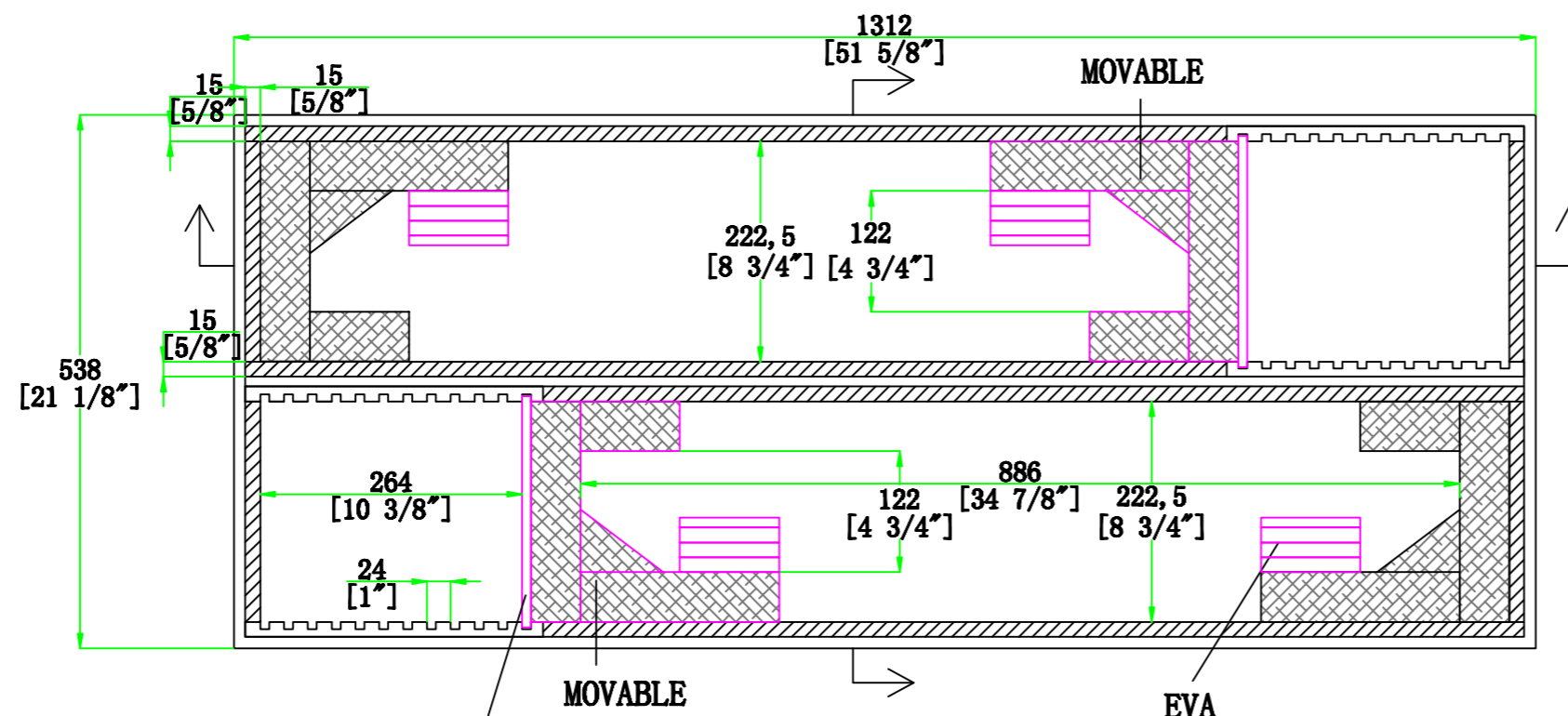
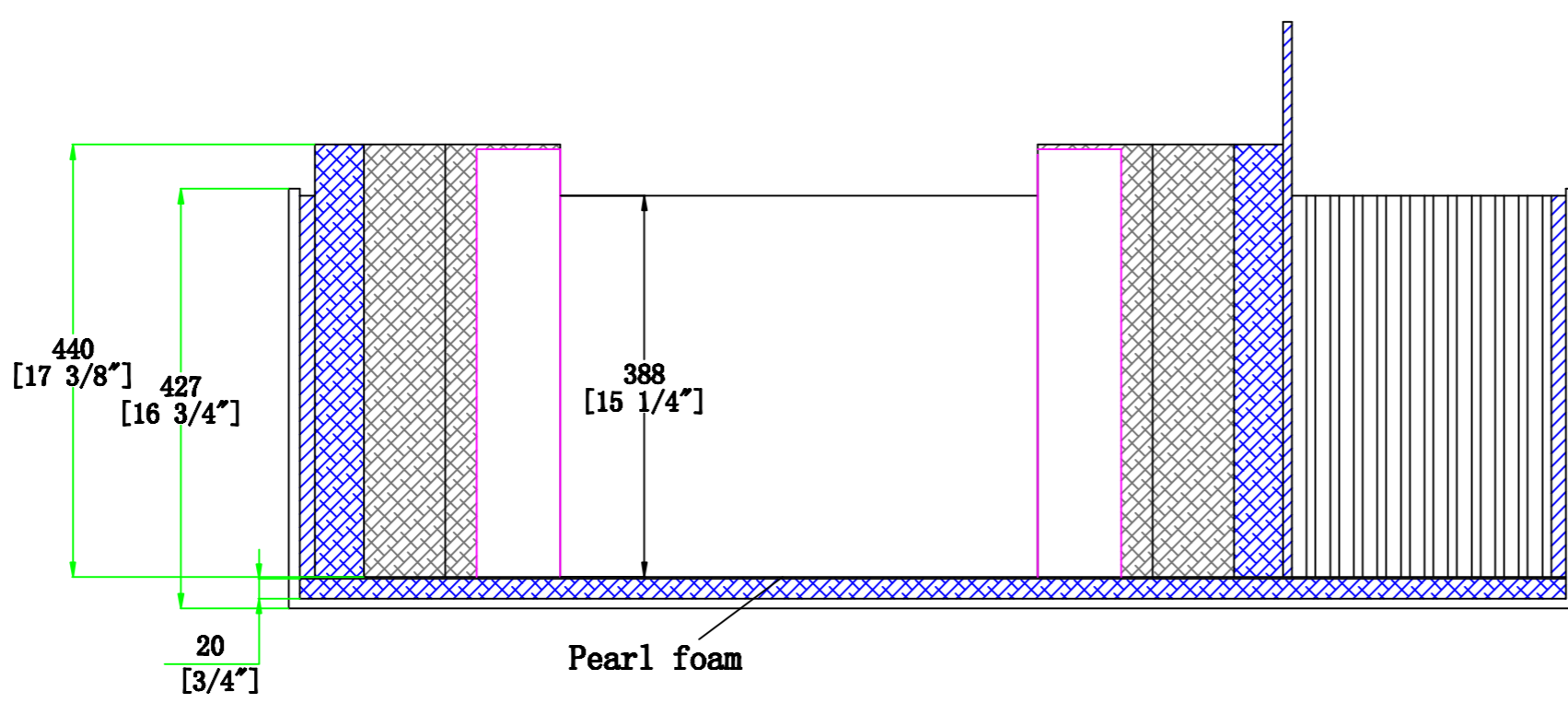
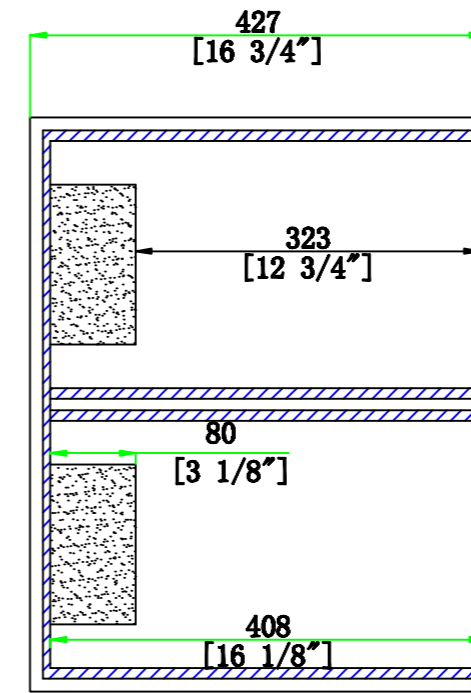

TOP VIEW OF BASE

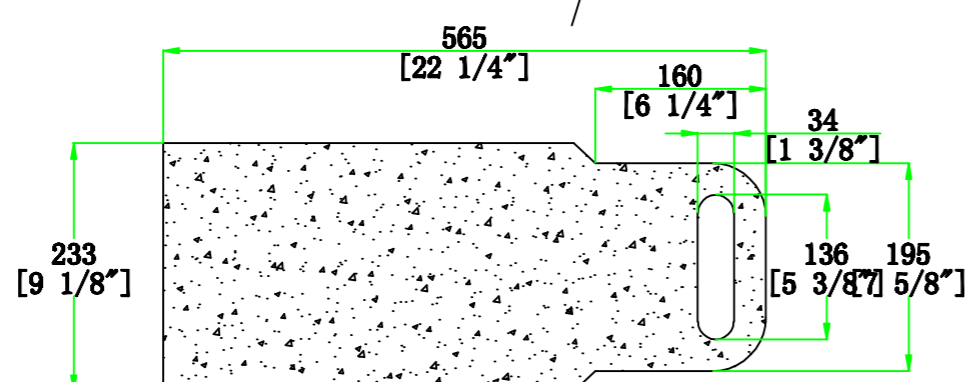
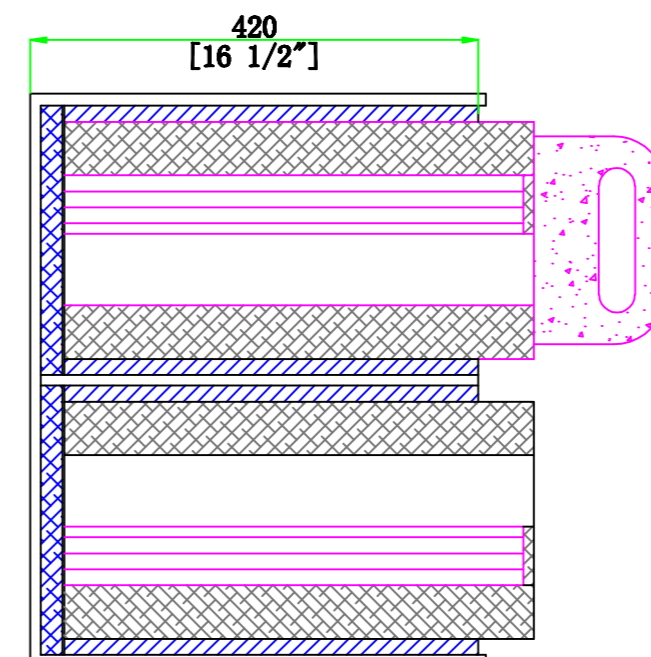

BOARD

